

MARK[®]

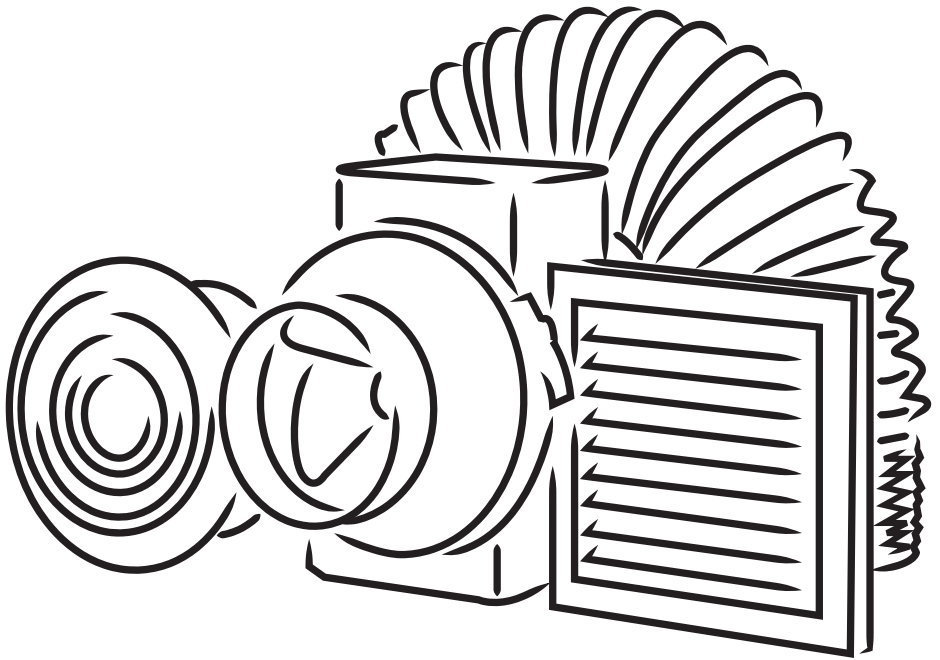

SHOWER FAN KIT

User Manual

S14-4219PCLEDD | S14-4219WHLEDD

+44 (0) 1302 741941 | sales@tlwglobal.com | tlwglobal.com

TLW Global Brunel House, Brunel Close, Harworth, Doncaster, DN11 8QA

CONTENTS

Operation Guidelines	2
Box Contents	3
Tools Required	4
Register Your Warranty	4
Before You Start	5
Kit Dimensions	6
Fan Installation Instructions	7
Electrical Wiring	8
Ducting Installation Instructions	9
Adjusting The Timer Settings	11
Maintenance	12
Technical Maintenance	13
Troubleshooting	13
Storage and Transportation Regulations	13
Manufacturers Warranty	14
Commissioning	15
Date Of Manufacture	16

OPERATION GUIDELINES

The fan is rated for connection to single-phase AC power mains.

Power supply parameters are stated on the unit packaging and the label on the unit casing.

Ingress protection rating against access to hazardous parts and water ingress is IP45.

ATTENTION! The IP rating is indicated for an assembled unit.

The fan is rated for operation at ambient temperatures ranging from +1 °C to +40 °C.

WARNING! Do not operate the fan outside the specified temperature range.

The unit is rated as a Class II (220-240 V, 50 Hz) or Class III (12 V/50 Hz) electrical appliance and requires no grounding.



**THE PRODUCT MUST BE DISPOSED SEPARATELY AT THE END OF ITS SERVICE LIFE.
DO NOT DISPOSE THE UNIT AS UNSORTED DOMESTIC WASTE.**

BOX CONTENTS

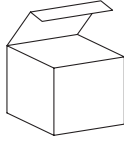

BOX



BAG

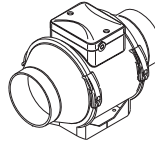

FAN

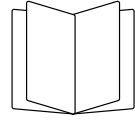

INSTRUCTIONS



SCREW KIT



CABLE TIES

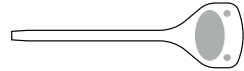

PLASTIC ADJUSTMENT TOOL*
*T FANS ONLY

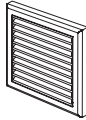

EXTERIOR VENT

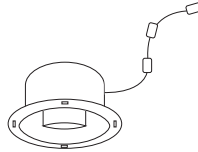

LED LIGHT

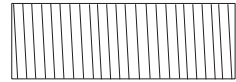

FLEXIBLE DUCTING

NOTE!

All packaging is certified as being either recyclable or compostable. Please dispose of all packaging using the correct recycling bin or bank.

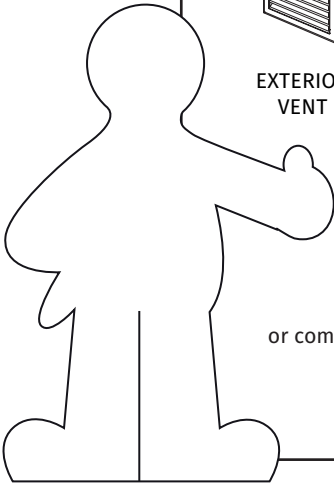

TOOLS REQUIRED



Although installation is a DIY project, safety is of the utmost importance when undertaking any home improvement.

Before you start.

Disable the power to the bathroom circuit from your electrical panel and employ a voltage tester to verify the absence of electricity in the area.

Equip yourself with safety glasses and gloves to shield against debris and sharp edges. Use the correct tools in a correct and safe manner and the project can be completed in a timely fashion.



BEFORE YOU START

This user's manual is a main operating document intended for technical, maintenance and operating staff.

The manual contains information about purpose, technical details, operating principle, design and installation of the Fan and all its modifications.

Technical and maintenance staff must have theoretical and practical training in the field of ventilation systems and should be able to work in accordance with workplace safety rules as well as construction norms and standards applicable in the territory of the country.

PLEASE READ THE USER'S MANUAL CAREFULLY PRIOR TO INSTALLING, CONNECTION TO POWER MAINS AND OPERATING THE UNIT.

THE MANUFACTURING COMPANY SHALL NOT BE RESPONSIBLE FOR DAMAGE TO HEALTH AND PROPERTY OF THE CUSTOMER CAUSED BY THE CUSTOMER'S VIOLATING THE USER'S MANUAL.

FOLLOW THE USER'S MANUAL REQUIREMENTS TO ENSURE DURABLE OPERATION OF THE UNIT, ITS MECHANICAL AND ELECTRICAL RELIABILITY.

KEEP THIS USER'S MANUAL.

This unit is not intended for use by persons (including children) with reduced physical, sensory or mental capabilities, or lack of experience and knowledge, unless they have been given supervision or instruction concerning use of the unit by a person responsible for their safety.

Children should be supervised to ensure that they do not play with the unit.

This appliance can be used by children aged from 8 years and above and persons with reduced physical, sensory or mental capabilities or lack of experience and knowledge if they have been given supervision or instruction concerning use of the appliance in a safe way and understand the hazards involved.

Cleaning and user maintenance shall not be made by children without supervision.

Children shall not play with the appliance.

Precautions must be taken to avoid the back-flow of gases into the room from the open flue of gas or other fuel-burning appliances.

Ensure that the unit is switched off from the supply mains before removing the guard.

Connection to the mains must be made through a disconnecting device, which is integrated into the fixed wiring system in accordance with the wiring rules for design of electrical units, and has a contact separation in all poles that allows for full disconnection under overvoltage category III conditions.

All operations described in this manual must be performed by

qualified personnel only, properly trained and qualified to install, make electrical connections and maintain ventilation units.

Do not attempt to install the product, connect it to the mains or perform maintenance yourself.

This is unsafe and impossible without special knowledge.

Disconnect the power supply prior to any operations with the unit.

All user's manual requirements as well as the provisions of all the applicable local and national construction, electrical, and technical norms and standards must be observed when installing and operating the unit.

Disconnect the unit from the power supply prior to any connection, servicing, maintenance and repair operations.

Only qualified electricians with a work permit for electrical units up to 1000 V are allowed for installation. The present user's manual should be carefully read before beginning works.

Check the unit for any visible damage of the impeller, the casing, and the grille before starting installation. The casing internals must be free of any foreign objects that can damage the impeller blades.

While mounting the unit, avoid compression of the casing!

Deformation of the casing may result in motor jam and excessive noise.

Misuse of the unit and any unauthorised modifications are not allowed.

Do not expose the unit to adverse atmospheric agents (rain, sun, etc.).

Transported air must not contain any dust or other solid impurities, sticky substances or fibrous materials.

Do not use the unit in a hazardous or explosive environment containing spirits, gasoline, insecticides, etc.

Do not close or block the intake or extract vents in order to ensure the efficient air flow.

Do not sit on the unit and do not put objects on it.

The information in this user's manual was correct at the time of the document's preparation.

The Company reserves the right to modify the technical characteristics, design, or configuration of its products at any time in order to incorporate the latest technological developments.

Never touch the unit with wet or damp hands.

Never touch the unit when barefoot.

BEFORE INSTALLING ADDITIONAL EXTERNAL DEVICES, READ THE RELEVANT USER MANUALS.

Combined Safety and Building Regulations for Bathroom Extractor Fan Installation

Certification: All electrical work in bathrooms must comply with Part P of the Building Regulations, requiring certain works to be notified to and inspected by local building control or carried out by a registered electrician.

RCD Protection: Consistent with IEE Wiring Regulations, Part P emphasises the use of RCDs for additional protection against electric shock, especially in high-risk areas like bathrooms.

Adequate Ventilation: Ensure the extractor fan provides adequate ventilation for the size of the bathroom, meeting the specific airflow requirements set out in Part F Building Regulations to prevent mould and condensation.

External Venting: The fan should vent directly to the outside to effectively remove moist air from the bathroom, in line with Part F guidelines.

Safe Installation Practices: Isolation and Switching: Install a means of isolation that is accessible outside the bathroom to allow for safe maintenance and emergency disconnection.

Professional Installation: Building Regulations recommend that installation work is carried out or inspected by competent persons who are registered with a competent person scheme, ensuring adherence to both electrical and building standards.

Documentation and Records: Keep detailed records of the installation and any inspections or certifications. This documentation is crucial for compliance with Part P Building Regulations and may be required for future property transactions.

By integrating the requirements of both the IEE Wiring Regulations and the UK Building Regulations, you ensure that your bathroom extractor fan installation is not only electrically safe but also contributes to the overall ventilation and air quality standards required in residential bathrooms.

This comprehensive approach safeguards the well-being of occupants and the integrity of the property.



KIT DIMENSIONS

External Grille

Dimensions (mm)				
□B	□H	L	L1	Flange (D)
154	110	15	45	100

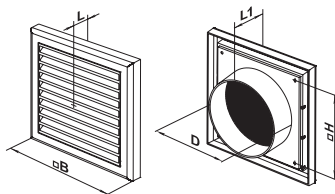

LED Light

Dimensions (mm)			
D	D1	H	H1
96	139	72	13

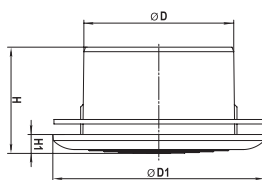

Ducting

Dimensions (mm)	
D	L
100	6000*

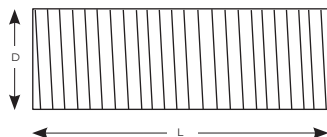

*A maximum of 1.5m(1500mm) of flexible ducting should be used in order to adhere with building regulations Part F Volume 1: Dwellings

Fan

Dimensions (mm)			
∅D	B	H	L
96	167	190	246

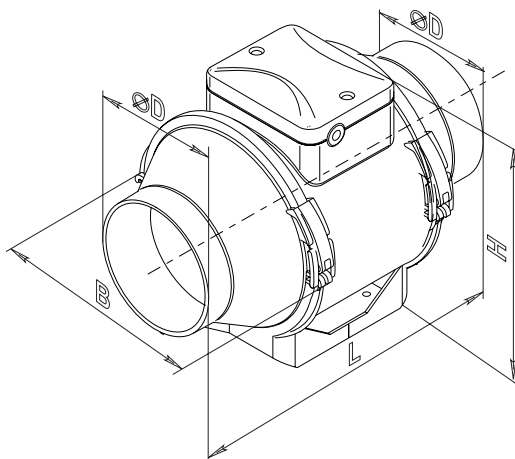

FAN INSTALLATION INSTRUCTIONS

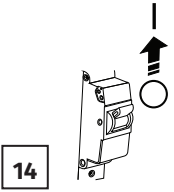
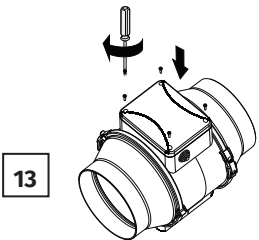
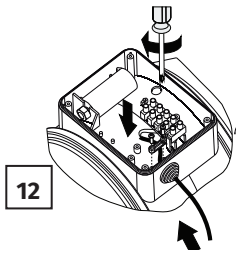
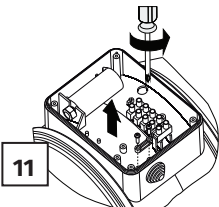
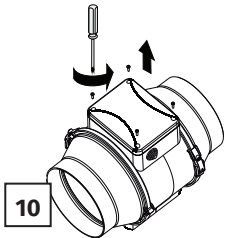
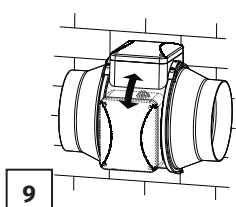
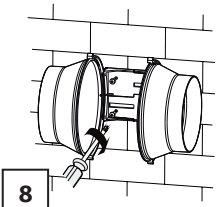
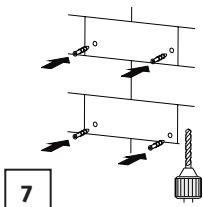
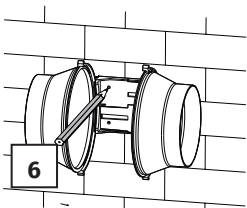
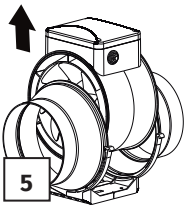
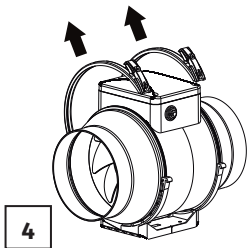
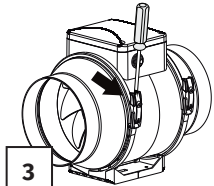
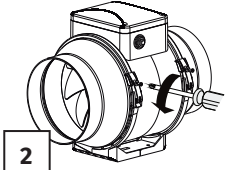
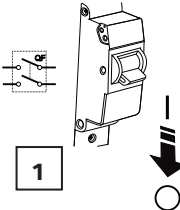

FAN ELECTRICAL WIRING

Fan's with a timer require a switched live, permanent live and neutral mains voltage connection to function. For most installations, the electrical supply is provided from the lighting circuit. Please see diagram below.

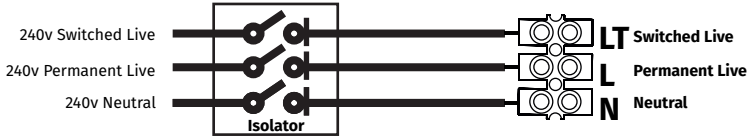

LED LIGHT ELECTRICAL WIRING

LED Light requires a permanent live and neutral mains voltage connection to function. For most installations, the electrical supply is provided from the lighting circuit. Please see diagram below.

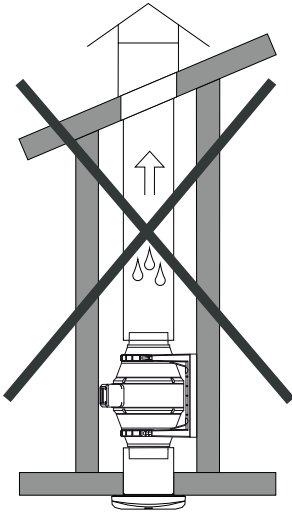
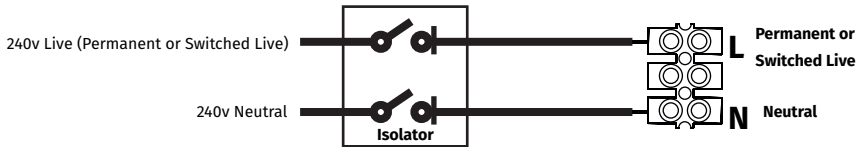

The fan should NOT be installed in a ceiling with vertical duct to outside.

A condensate or water trap should be installed if there is any risk of water or liquid entering the fan. *Trap Sold Separately*.



DUCTING INSTALLATION INSTRUCTIONS 1 OF 2

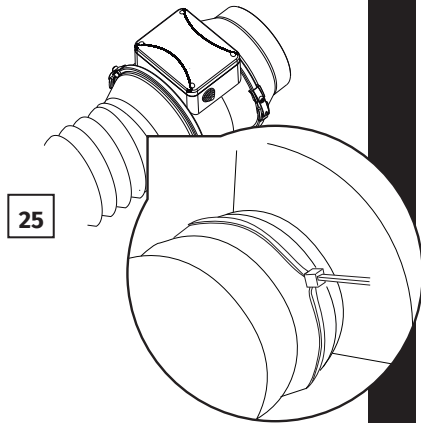
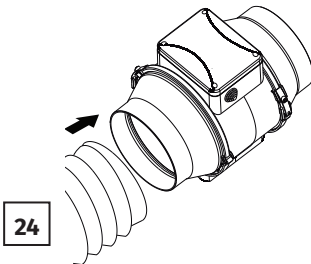
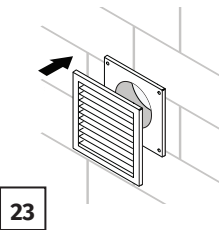
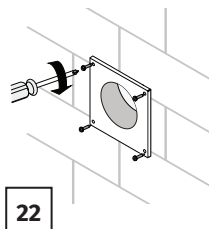
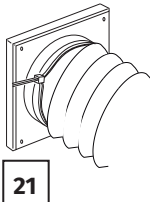
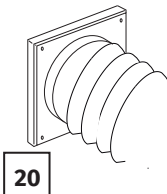
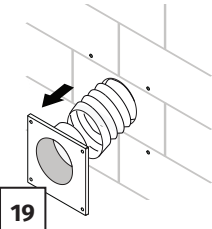
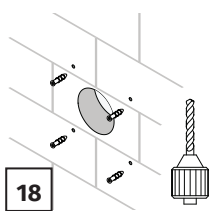
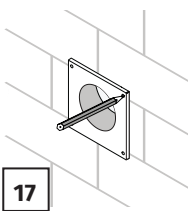
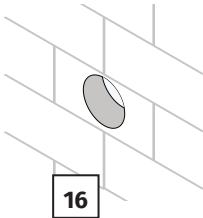
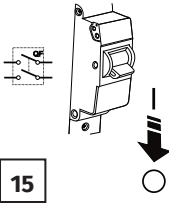

DUCTING INSTALLATION INSTRUCTIONS 2 OF 2

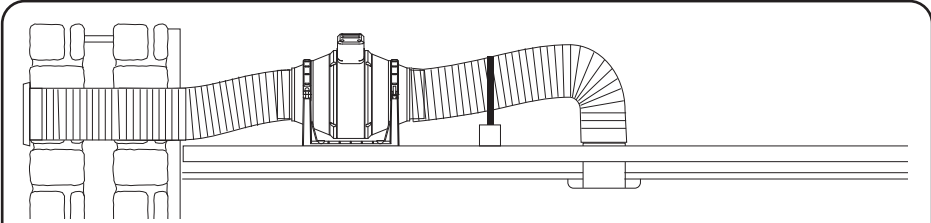
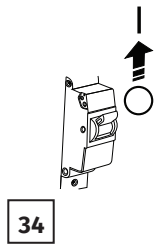
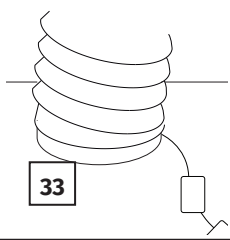
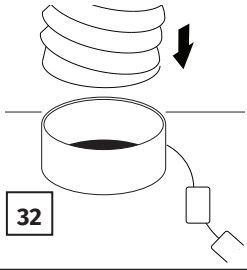
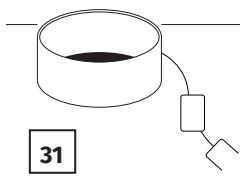
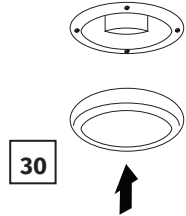
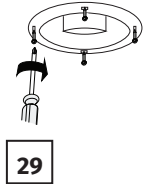
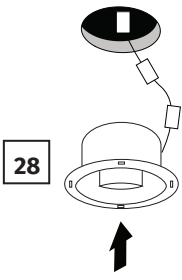
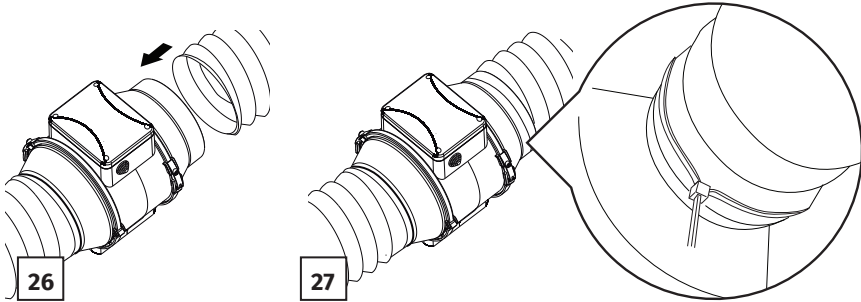

Always support flexible ducting to stop sagging.
Supports every 400mm are advised.
Flexible ducting must be pulled/extended to a minimum of 90% of it's total length.
Ducting must not be compressed or restricted and should be installed in straight lines where possible.
A maximum of 1.5m (1500mm) of flexible ducting should be used in order to adhere with building regulations Part F Volume 1: Dwellings



ADJUSTING THE TIMER SETTINGS

Disconnect the power supply before making any changes or adjustments to the timer.

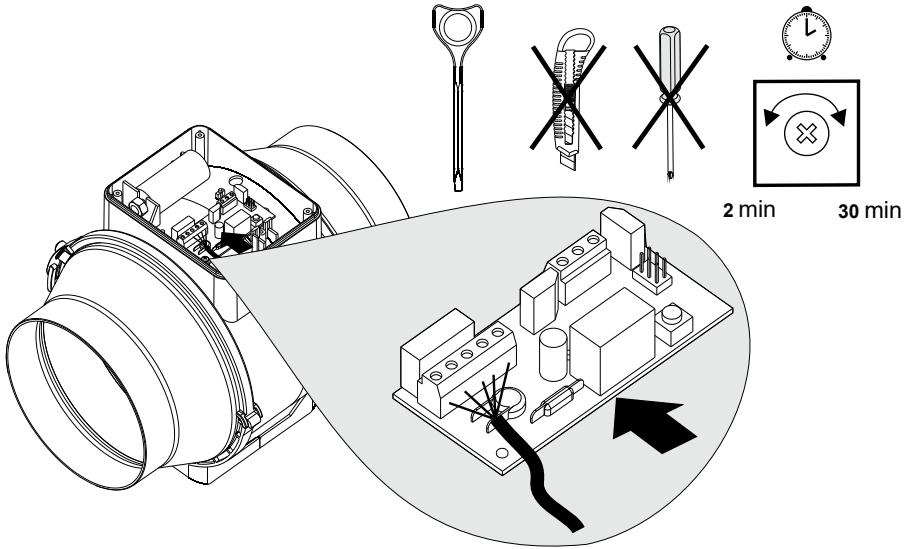

To adjust the timer settings use the plastic adjustment tool provided.

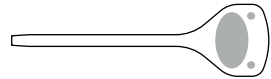

RUN ON TIMER SETTING

Run-on setting is adjustable from 2 to 30 minutes.

TURN CLOCKWISE = Longer Delay

TURN ANTI CLOCKWISE = Shorter Delay

MAINTENANCE

Disconnect the fan from mains power prior to any servicing and maintenance operations.

Maintenance means regular cleaning of the fan surfaces of dirt and dust.

To clean the fan, wipe its surfaces with a cloth using a mild soap solution, then wipe the surfaces dry.

Avoid water dripping on the motor and circuit board.

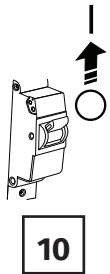
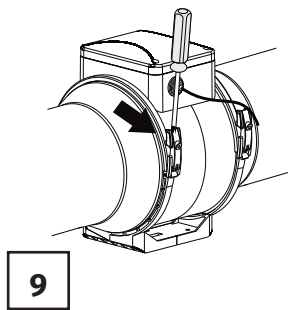
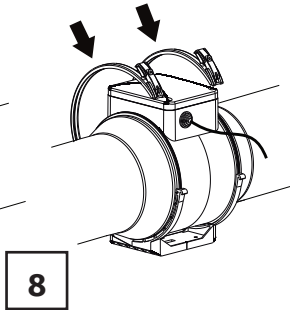
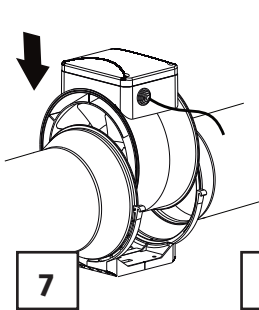
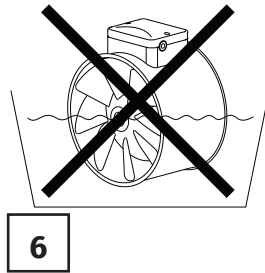
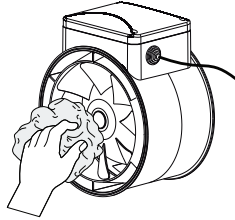
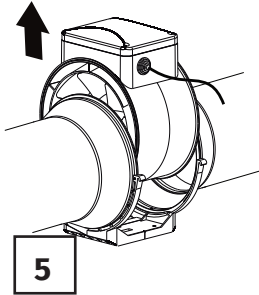
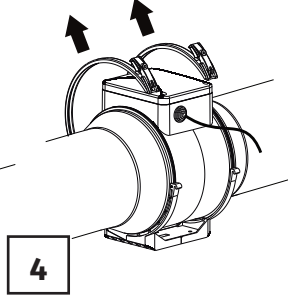
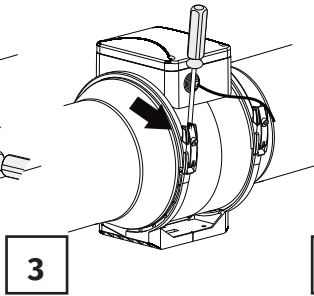
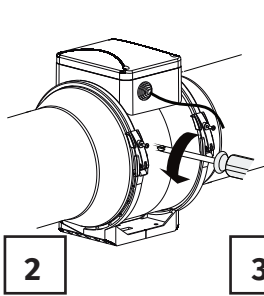
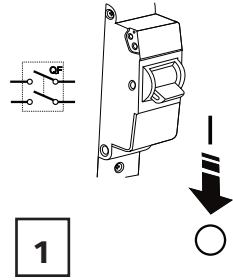

TECHNICAL MAINTENANCE

The fan maintenance interval is at least once per 6 months.

Maintenance Steps:

- Disconnect the fan from power supply and make sure electricity has been turned off (Fig. 1).
- Remove the front panel, wipe the fan with a dry cloth or a brush (Fig. 2/3).

- Clean the front panel under running water (Fig. 3/4).
- Wipe the fan surfaces dry.
- Cover the fan with the front panel (Fig. 5).
- Connect power supply to the fan (Fig. 6).

WARNING! Do not allow water or liquid to come into contact with electric components!

TROUBLE SHOOTING

Problem	Possible Reasons	Troubleshooting
When the unit is connected to power mains, the fan does not rotate and does not respond to any controls.	No power supply.	Make sure the power supply line is connected correctly, otherwise troubleshoot a connection error.
	Internal connection fault.	Contact the Seller.
Low air flow.	The ventilation system is clogged.	Clean the ventilation system.
Increased noise, vibration.	The impeller is clogged.	Clean the impeller.
	The fan is not secured well or is not mounted properly.	Troubleshoot the installation error.
	The ventilation system is clogged.	Clean the ventilation system.

STORAGE AND TRANSPORTATION REGULATIONS

- Store the unit in the manufacturer's original packaging box, in a dry, closed ventilated premise with temperature range from +5°C to + 40°C and relative humidity up to 70%.
- Storage environment must not contain aggressive vapours and chemical mixtures provoking corrosion, insulation and sealing deformation.
- Use suitable hoist machinery for handling and storage operations to prevent possible damage to the unit.
- Follow the handling requirements applicable for the particular type of cargo.
- The unit can be carried in the original packaging by any mode of transport provided proper protection against precipitation and mechanical damage. The unit must be transported only in the working position.
- Avoid sharp blows, scratches or rough handling during loading and unloading.
- Prior to the initial power-up after transportation at low temperatures, allow the unit to warm up at operating temperature for at least 3-4 hours.

MANUFACTURERS WARRANTY

The product is in compliance with EU norms and standards on low voltage guidelines and electromagnetic compatibility.

We hereby declare that the product complies with the provisions of Electromagnetic Compatibility (EMC) Directive 2014/30/EU of the European Parliament and of the Council, Low Voltage Directive (LVD) 2014/35/EU of the European Parliament and of the Council and CE-marking Council Directive 93/68/EEC. This certificate is issued following test carried out on samples of the product referred to above.

The manufacturer hereby warrants normal operation of the unit for 12 months after the retail sale date provided the user's observance of the transportation, storage, installation, and operation regulations. Should any malfunctions occur in the course of the unit operation through the Manufacturer's fault during the guaranteed period of operation, the user is entitled to get all the faults eliminated by the manufacturer by means of warranty repair at the factory free of charge. The warranty repair includes work specific to elimination of faults in the unit operation to ensure its intended use by the user within the guaranteed period of operation. The faults are eliminated by means of replacement or repair of the unit components or a specific part of such unit component.

The warranty repair does not include:

- routine technical maintenance
- unit installation/dismantling
- unit setup

To benefit from warranty repair, the user must provide the unit, the user's manual with the purchase date stamp, and the payment paperwork certifying the purchase. The unit model must comply with the one stated in the user's manual. Contact the Seller for warranty service.

The manufacturer's warranty does not apply to the following cases:

- User's failure to submit the unit with the entire delivery package as stated in the user's manual including submission with missing component parts previously dismounted by the user.
- Mismatch of the unit model and the brand name with the information stated on the unit packaging and in the user's manual.
- User's failure to ensure timely technical maintenance of the unit.
- External damage to the unit casing (excluding external modifications as required for installation) and internal components caused by the user.
- Redesign or engineering changes to the unit.
- Replacement and use of any assemblies, parts and components not approved by the manufacturer.
- Unit misuse.
- Violation of the unit installation regulations by the user.
- Violation of the unit control regulations by the user.
- Unit connection to power mains with a voltage different from the one stated in the user's manual.
- Unit breakdown due to voltage surges in power mains.
- Discretionary repair of the unit by the user.
- Unit repair by any persons without the manufacturer's authorisation.
- Expiration of the unit warranty period.
- Violation of the unit transportation regulations by the user.
- Violation of the unit storage regulations by the user.
- Wrongful actions against the unit committed by third parties.
- Unit breakdown due to circumstances of insuperable force (fire, flood, earthquake, war, hostilities of any kind, blockades).
- Missing seals if provided by the user's manual.
- Failure to submit the user's manual with the unit purchase date stamp.
- Missing payment paperwork certifying the unit purchase.



FOLLOWING THE REGULATIONS STIPULATED HEREIN WILL ENSURE A LONG AND TROUBLE-FREE OPERATION OF THE UNIT.



USER'S WARRANTY CLAIMS SHALL BE SUBJECT TO REVIEW ONLY UPON PRESENTATION OF THE UNIT, THE PAYMENT DOCUMENT AND THE USER'S MANUAL WITH THE PURCHASE DATE STAMP.

COMMISSIONING

SFP:

.....

AIR FLOW:

.....

COMMISSIONED BY

NAME:

.....

COMPANY:

.....

DATE:

.....

SIGNED:

.....

NOTES

.....

.....

.....

.....

.....

.....

.....

.....

MARK[®]

Date of manufacture

TECHNICAL SUPPORT:

Tel: 01302 741944

Email: vent.tech@tlwglobal.com

Opening Hours: 9am - 5pm Monday – Friday

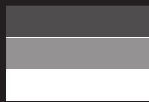

DESIGNED IN
GERMANY



ASSEMBLED
IN THE UK



UM-1_S14-4219PCLEDD_S14-4219WHLEDD